

MEF

Technical Specification

MEF 22

Mobile Backhaul Implementation Agreement Phase 1

January 2009

Disclaimer

The information in this publication is freely available for reproduction and use by any recipient and is believed to be accurate as of its publication date. Such information is subject to change without notice and the Metro Ethernet Forum (MEF) is not responsible for any errors. The MEF does not assume responsibility to update or correct any information in this publication. No representation or warranty, expressed or implied, is made by the MEF concerning the completeness, accuracy, or applicability of any information contained herein and no liability of any kind shall be assumed by the MEF as a result of reliance upon such information.

The information contained herein is intended to be used without modification by the recipient or user of this document. The MEF is not responsible or liable for any modifications to this document made by any other party.

The receipt or any use of this document or its contents does not in any way create, by implication or otherwise:

- (a) any express or implied license or right to or under any patent, copyright, trademark or trade secret rights held or claimed by any MEF member company which are or may be associated with the ideas, techniques, concepts or expressions contained herein; nor
- (b) any warranty or representation that any MEF member companies will announce any product(s) and/or service(s) related thereto, or if such announcements are made, that such announced product(s) and/or service(s) embody any or all of the ideas, technologies, or concepts contained herein; nor
- (c) any form of relationship between any MEF member companies and the recipient or user of this document.

Implementation or use of specific Metro Ethernet standards or recommendations and MEF specifications will be voluntary, and no company shall be obliged to implement them by virtue of participation in the Metro Ethernet Forum. The MEF is a non-profit international organization accelerating industry cooperation on Metro Ethernet technology. The MEF does not, expressly or otherwise, endorse or promote any specific products or services.

© The Metro Ethernet Forum 2009. All Rights Reserved.

Table of Contents

1.	Abstract.....	1
2.	Abbreviations	1
3.	Introduction.....	2
4.	Scope and definitions	2
4.1	Reference models	2
4.2	Use Cases.....	3
4.3	In Scope	5
4.4	Out of Scope	5
4.5	Phases of this Implementation Agreement	5
4.5.1	Phase 1 – Current Document.....	5
4.5.2	Later phases.....	6
5.	Compliance Levels	6
6.	UNI Requirements	6
7.	Ethernet Service Requirements	7
7.1	Class of Service Requirements	7
7.2	Applying MEF Service Definitions to Mobile Backhaul	9
7.2.1	Ethernet Private Line Service.....	10
7.2.2	Ethernet Virtual Private Line Service	11
7.2.3	Ethernet Private LAN Service.....	11
7.2.4	Ethernet Virtual Private LAN Service	12
7.2.5	Ethernet Private Tree Service.....	13
7.2.6	Ethernet Virtual Private Tree Service	14
7.3	Synchronization	15
7.3.1	Packet Based Methods	16
7.3.2	Synchronous Ethernet Methods	17
7.3.3	Synchronization Requirements for TDM-Based Interfaces	17
8.	Generic Inter-working Function MEN Interface Requirements.....	18
9.	References	19
10.	Appendix A – Generic Inter-working Function (Informative).....	21
11.	Appendix B – Mobile Backhaul User Traffic Classes (Informative)	22
12.	Appendix C – Mobile Backhaul Services (Informative).....	23
12.1	Use Case 1: EVP Line per RAN BS.....	23
12.2	Use Case 2: EVP Tree per group of RAN BSs.....	25
12.3	Use Case 3: EVP Tree per Service	27
12.4	Configuration alternatives for Management plane	28

List of Figures

Figure 1 : Single MEN Domain Mobile Backhaul Reference Model.....	3
Figure 2: Use Case 1a	3
Figure 3: Use Case 1b	4
Figure 4: Use Case 2a	4
Figure 5: Use Case 2b	4
Figure 6 – Location of the UNI-C and UNI-N functions at the RAN BS and RAN NC.....	6
Figure 7: Ethernet Private Line (EPL) Service	10
Figure 8: Ethernet Virtual Private Line (EVPL) Service.....	11
Figure 9: Ethernet Private LAN (EP-LAN) Service	12
Figure 10: Ethernet Virtual Private LAN (EVP-LAN) Service.....	13
Figure 11: Ethernet Private Tree (EP-Tree) Service.....	14
Figure 12: Ethernet Virtual Private Tree (EVP-Tree) Service.....	15
Figure 13 : Example of packet based method with timing distribution of the Reference Timing Signal via Timestamps.....	16
Figure 14: Generic Inter-working Function	21
Figure 15: EVP Line per RAN BS – Use Case 1.....	24
Figure 16: EVP-Tree per group of RAN BSs – Use Case 2	26
Figure 17: CE-VLAN ID per service – Use Case 3.....	27
Figure 18: Ethernet Service for Management plane	29
Figure 19: Multiple CoS IDs on the EVC reserved for Management traffic.....	30

List of Tables

Table 1: Abbreviations.....	1
Table 2: Service Class Model for Mobile Backhauling.....	8
Table 3 : Examples of MBH Traffic Classes mapping into 4, 3 and 2 CoS Models	9
Table 4: WCDMA User Service Classes (Source: 3GPP 23.107).....	22
Table 5: WiMAX User Service Classes (Source: IEEE 802.16e)	22
Table 6: EVP Line per RAN BS – Use Case 1	24
Table 7: Example of CE-VLAN ID \ EVC mapping both at RAN BS UNI-N and at RAN NC UNI-N	25
Table 8: Example of multiple CoS IDs based on <EVC+PCP> – Use Case 1.....	25
Table 9: EVP Tree per group of RAN BSs – Use Case 2.....	26
Table 10: EVP Tree per Service – Use Case 3	28
Table 11: Example of CE-VLAN ID\EVC mapping both at RAN BS UNI-N and at RAN NC UNI-N	28
Table 12: CoS ID both per <EVC> and per <EVC+PCP> - Use Case 3	28
Table 13: Ethernet Service configuration for Management plane – An example.....	29
Table 14: Example of Multiple CoS IDs on the EVC reserved to Management.....	30

1. Abstract

This document identifies the service attribute requirements that apply to Ethernet Services and UNIs for mobile backhaul based on MEF standards. In addition, new interface and service attributes have been specified where needed. The services and requirements in this Implementation Agreement are based on the services defined in MEF 6.1 Ethernet Service Definitions – Phase 2 [1] and the attributes in MEF 10.1 Ethernet Service Attributes [2], and aims to be flexible to support a wide range of Ethernet and existing mobile network deployments.

2. Abbreviations

Abbreviation	Definition	Reference
3GPP	3 rd Generation Partnership Project	[14]
CE	Customer Edge	[2]
CoS	Class of Service	[2]
EPL	Ethernet Private Line	[1]
EVC	Ethernet Virtual Connection	[1]
EVPL	Ethernet Virtual Private Line	[1]
EP-LAN	Ethernet Private LAN	[1]
EVP-LAN	Ethernet Virtual Private LAN	[1]
EP-Tree	Ethernet Private Tree	[1]
EVP-Tree	Ethernet Virtual Private Tree	[1]
FD	Frame Delay	[2]
FDV	Frame Delay Variation	[2]
FLR	Frame Loss Ratio	[2]
GIWF	Generic Inter-working Function	This Document
MEN	Metro Ethernet Network (used interchangeably with Carrier Ethernet Network)	[2]
MTU	Maximum Transmission Unit	[2]
N/S	Not specified	
NTP	Network Time Protocol	[25]
PCP	Priority Code Point	[10]
PEC	Packet based Equipment Clocks	[18]
PDH	Plesiochronous Digital Hierarchy	[26]
PTP	Precision Time Protocol	[24]
RAN	Radio Access Network	This Document
RAN BS	RAN Base Station	This Document
RAN CE	RAN Customer Edge	This Document
RAN NC	RAN Network Controller	This Document
RNC	Radio Network Controller	[14]
SLA	Service Level Agreement	[2]
UNI	User Network Interface	[2]
VLAN	Virtual LAN	[2]

Table 1: Abbreviations

3. Introduction

The term mobile backhaul includes a spectrum of networks and network technologies, including the Radio Access Network (RAN) and Core Networks. This Implementation Agreement uses the term mobile backhaul to refer to the network between the base station site and the network controller site. Mobile backhaul networks have traditionally been realized using TDM and ATM technologies. However, next generation mobile equipment and networks will be based on Ethernet. Carrier Ethernet services will provide the connectivity in the mobile backhaul network, possibly in a converged network together with traditional fixed services.

Ethernet is becoming increasingly available, even at sites with access to legacy services. This opportunity allows mobile operators to make the choice of which transport technology to utilize. In some cases where there is circuit based equipment that is co-located with newer Ethernet based equipment it may be suitable to use a single transport technology to lower costs.

This document defines the Ethernet services requirements for the mobile backhaul. These definitions aim to support a wide range of Ethernet based mobile network deployments.

4. Scope and definitions

The scope reflects the ambitions for the first phase of the Mobile Backhaul Implementation Agreement. This section includes: a description of a mobile backhaul reference model; definitions of new reference points and functional elements; and describes use cases that reflect possible mobile backhaul deployments.

4.1 Reference models

A mobile backhaul network can take on a constellation of forms depending on factors such as transport technology, mobile standard, operator preference, etc. This Implementation Agreement (IA) focuses on the network between radio base stations and radio network controllers, herein referred to as mobile backhaul. The mobile backhaul can be interchanged with the MEN with respect to the reference model in this IA. Figure 1 describes a simple reference model where the mobile backhaul is a single Metro Ethernet Network (MEN) that connects the mobile network nodes, referred herein as RAN Customer Edge (RAN CE).

RAN CE is a generic term that identifies a mobile network node or site, such as a RAN Network Controller (RAN NC) or a RAN Base Station (RAN BS). A RAN NC may be a single network controller or a site composed of several network controllers including: OSS, WCDMA Radio Network Controller, or synchronization server. A RAN BS may also be a single base station or a collection of several base stations. Multiple RAN NCs and RAN BSs can be connected to the MEN at any given time.

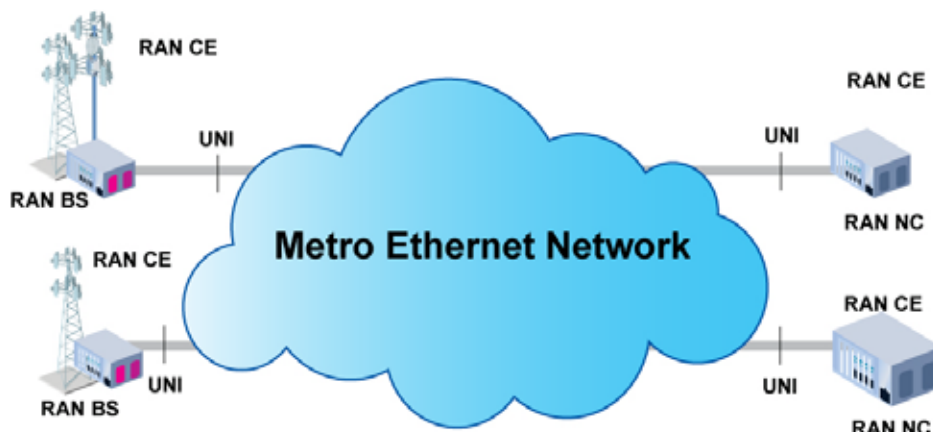

Figure 1 : Single MEN Domain Mobile Backhaul Reference Model

More complex scenarios involving multiple MEN domains are possible but these are out of scope for Phase 1 of the Mobile Backhaul Implementation Agreement and are left for further study.

4.2 Use Cases

Based on the basic reference model above in Figure 1 it is possible to derive the use cases below, where each use case presents a possible deployment scenario using Ethernet services. Although the use cases are not exhaustive of all possible deployment scenarios, they will be the foundation of the Mobile Backhaul Implementation Agreement Phase 1. The focus of this IA is to recommend capabilities at the UNI and applicable Ethernet Services in support of mobile backhaul; referencing MEF specifications, and proposing extensions when necessary. Details about traffic transmitted over Legacy Networks, e.g. ATM or TDM, are out of scope.

Use cases 1a and 1b below depict deployments where the RAN BS and RAN NC can not be directly connected to a UNI because they have non-Ethernet based interfaces, such as ATM or TDM. These interfaces are illustrated in Figure 2 and Figure 3 as Non-Ethernet I/F. Use cases 1a and 1b require that the RAN CEs first connect to a Generic Inter-working Function (GIWF), which in turn is connected to the UNI, see Section 10.

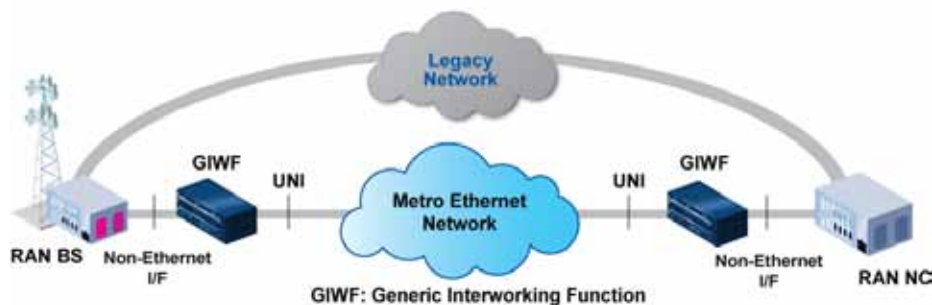

Figure 2: Use Case 1a

Use case 1a, above, illustrates a split access scenario where there are two parallel networks, a legacy network and MEN, that transport different types of mobile traffic. This may be appropriate in cases where an operator wants to offload low priority high bandwidth traffic from the legacy network to the MEN in order to scale after network demand. How and where traffic is split and sent over the legacy network is out of scope for this implementation agreement.

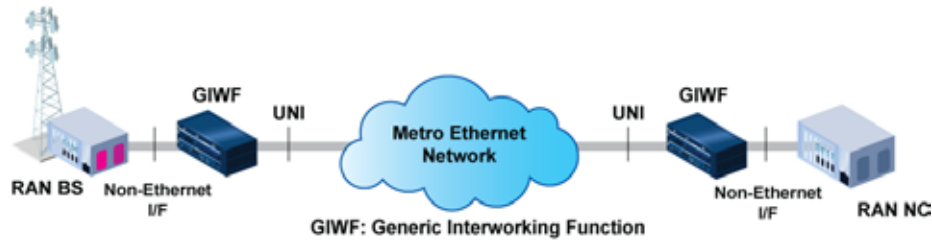

Figure 3: Use Case 1b

Figure 3 depicts a deployment scenario where the legacy network has been substituted by a Carrier Ethernet Network and where the RAN CE is connected to the MEN via a GIWF. In this use case all traffic from the RAN CE is transported over the MEN using Ethernet services.

The last two use cases illustrate RAN CE equipment that can be connected directly to the UNI via an Ethernet interface eliminating the need for a GIWF. Use case 2a is similar to use case 1a in the way the MEN is used to offload certain traffic, such as low priority high bandwidth traffic, from the legacy network. How the RAN CE transports real-time and synchronization traffic via the legacy network is out of scope for this implementation agreement.

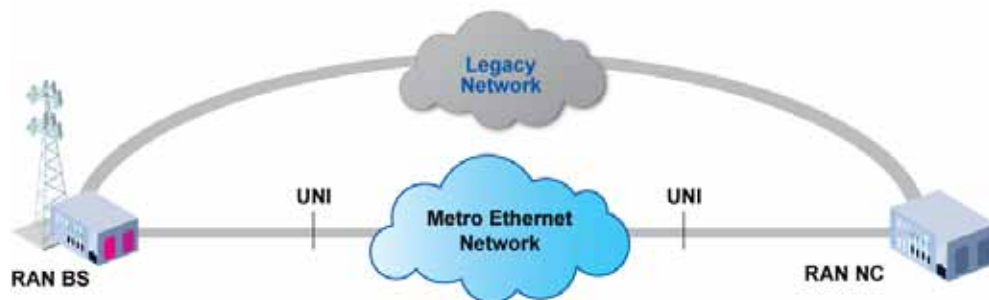

Figure 4: Use Case 2a

Lastly, Figure 5 shows the case where all traffic is transported via Ethernet services over the MEN. How the Ethernet services are realized may vary depending on the mobile technology that is deployed, vendor equipment, operator requirements, and the type of services offered by the carrier.



Figure 5: Use Case 2b

4.3 In Scope

The following are within the scope of this Implementation Agreement:

- Utilize existing MEF technical specifications with required extensions to interface and service attributes.
- Provide requirements for UNI-C and UNI-N beyond those in [3] and [4].
- Define requirements for Ethernet Services.
- Provide requirements for Link OAM and Service OAM Fault Management.
- A single Metro Ethernet Network with external interfaces being only UNIs.
- Provide high-level requirements for Class of Service.
- Define synchronization requirements where possible for transparent packet based synchronization methods.
- Functional requirements applicable to GIWF interfaces.

4.4 Out of Scope

Topics that are not within the scope of this Implementation Agreement include:

- Provide an architectural and functional description of the MEN internals.
- Provide a normative definition or implementation specification of the Generic Inter-working Function.
- Provide details regarding Legacy Networks.
- Define synchronization architectures or promote any particular synchronization technology.
- Define mobile network evolution scenarios.

4.5 Phases of this Implementation Agreement

To manage the complexity and schedule of this document it has been assumed that the scope would be limited initially, with additional requirements to be included in subsequent phases. In this section we summarize the functionality of the initial Phase 1, and provide a few items that have been identified as candidates for inclusion in later phases of the IA.

4.5.1 Phase 1 – Current Document

- 1.) Ethernet Virtual Connections (EVC) span a single MEN.
- 2.) Synchronization is either delivered outside of the Ethernet transport network or using a packet based method that is transparent to the MEN, e.g. treated as standard Service Frames.
- 3.) The mobile standards that are considered are: GSM, WCDMA, CDMA2000, and WiMAX 802.16e.

4.5.2 Later phases

- 1.) EVCs spanning arbitrary number of MENs.
- 2.) Other synchronization methods.
- 3.) Other mobile standards, such as LTE.
- 4.) Extended architecture scope, e.g. mobile core network and additional mobile network reference points.

5. Compliance Levels

The key words "**MUST**", "**MUST NOT**", "**REQUIRED**", "**SHALL**", "**SHALL NOT**", "**SHOULD**", "**SHOULD NOT**", "**RECOMMENDED**", "**MAY**", and "**OPTIONAL**" in this document are to be interpreted as described in IETF RFC 2119 [12]. All key words must be in upper case, bold text.

6. UNI Requirements

The UNI requirements may not be uniform for all UNIs in the mobile backhaul. This document distinguishes the requirements for the UNI at the RAN BS and the UNI at the RAN NC, as illustrated in Figure 6, when necessary. Requirements specified for the UNI apply to both the RAN BS UNI and RAN NC UNI, unless specified otherwise.

Note: Each RAN BS and each RAN NC may be considered as a single device, such as a base station or network controller, or site with several network devices. As per MEF 11 [7], it is assumed that the UNI-C or UNI-N functions can be distributed across one or more devices in such a manner that all the required UNI functions are performed on all ingress and egress Service Frames at the UNI reference point.

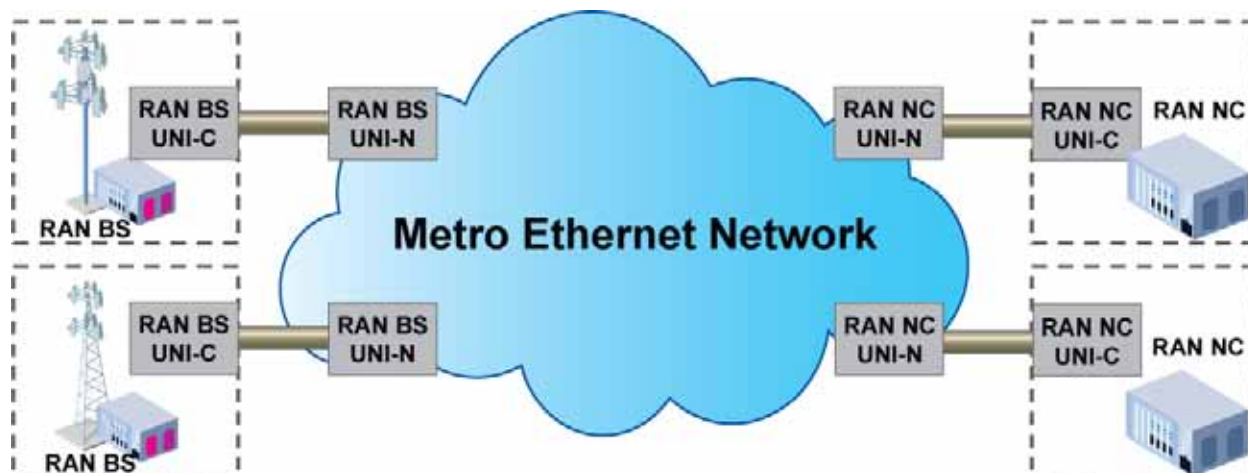

Figure 6 – Location of the UNI-C and UNI-N functions at the RAN BS and RAN NC

[R1] The UNI-C **MUST** be compliant with a UNI Type 1.2 as per [3].

[R2] The UNI-N **MUST** be compliant with a UNI Type 1.2 as per [3].

Ethernet OAM is a term used in this IA to collectively refer to Link OAM and Service OAM. Ethernet OAM requirements are not specified in any current mobile standards from 3GPP, 3GPP2 or IEEE 802.16 and have typically not been implemented on mobile equipment. However, Ethernet OAM is desirable for fault management, connectivity management, and performance monitoring of the Ethernet service. For example, Ethernet OAM for each subscriber EVC at the UNI could be implemented in the RAN NC and RAN BS to convey Ethernet connectivity state and performance.

Note: Link OAM and Service OAM are OAM mechanisms with similar fault management capabilities, but operate on different layers. Link OAM monitors the TRANS Layer (Physical Layer) by running Link OAM frames between the UNI-C and UNI-N. Service OAM, on the other hand, monitors the ETH Layer (Ethernet Services Layer) and may span one or multiple Ethernet Links. Service OAM may also be configured to monitor the link between the UNI-C and UNI-N. Typically either Link OAM or Service OAM are used to monitor the UNI, but not both, as this may potentially introduce contradictory measurement results.

- [R3] The UNI-C **SHOULD** be compliant with a UNI Type 2.1 as per [4].
- [R4] The UNI-N **SHOULD** be compliant with a UNI Type 2.1 as per [4].
- [R5] If the UNI is a UNI Type 2.1, then Link OAM as per [4] **SHOULD** be supported.
- [R6] The UNI-C **MAY** be compliant with a UNI Type 2.2 as per [4].
- [R7] The UNI-N **MAY** be compliant with a UNI Type 2.2 as per [4].

7. Ethernet Service Requirements

7.1 Class of Service Requirements

Mobile standards defined by 3GPP, 3GPP2, and IEEE 802.16 do not define requirements for the number of service classes that must be available in an Ethernet or IP based mobile backhaul network, but do identify user traffic classes on the radio interface. Section 11 is an informative appendix that examines user traffic classes defined by some mobile standards. In addition to these user traffic classes there is also synchronization, control, and signaling traffic between RAN BSs and RAN NCs.

The number of classes of service used is typically steered by equipment manufacturer implementation and recommendations, or mobile operator preference. This means the number of classes of service can theoretically range from a single Class of Service (CoS) to the maximum number of classes available for a given service. The latter may allow the option of defining a CoS for each different traffic class. In the event there are fewer classes of service available than the number of different traffic classes, another approach consists of defining a limited number of service classes and aggregating traffic classes requiring similar service performance.

There is a prerequisite that the performance requirements for each CoS must be dependent on the most stringent application performance requirement for a particular CoS. For example, if synchronization and voice share the same CoS then the performance requirements must be such that both traffic types can be delivered while achieving the requisite service quality. Table 3 provides a few recommendations for mapping certain traffic types to different CoS.

Note: the names of the traffic classes used in Table 3 are meant to represent a non-exhaustive set of generic traffic classes that could apply to all the mobile standards reference in this IA.

Another issue that could influence the suitable number of mobile backhaul CoS is that some traffic classes, such as packet-based timing, could require a more stringent level of performance than real-time services. This can be addressed in at least two ways: either defining a single CoS for both synchronization and real-time traffic classes or reserving a CoS yielding minimal FD and FDV to the synchronization traffic class only. In the former the most stringent performance requirements would be derived from the synchronization traffic class and apply to real-time traffic as well; in the latter real-time services are not affected by these stringent requirements but an additional CoS is required.

[R8] Within a single MEN it is **RECOMMENDED** to have a dedicated CoS characterized by minimal FD and FDV for packet-based timing traffic.

The CoS schema for supporting the entire set of traffic classes (user traffic, packet-based timing, control and signaling) used for mobile backhaul could be based on the service classes defined in Table 3.

Service Class Name	Bandwidth Profile	CoS Performance Objectives		
		FD	FDV	FLR
Very High (H ⁺)	$CIR > 0$ $EIR = 0$	A_{FD}	A_{FDV}	A_{FLR}
High (H)	$CIR > 0$ $EIR = 0$	B_{FD}	B_{FDV}	B_{FLR}
Medium (M)	$CIR > 0$ $EIR \geq 0$	C_{FD}	C_{FDV}	C_{FLR}
Low (L)	$CIR \geq 0$ $EIR \geq 0^*$	D_{FD}	D_{FDV}	D_{FLR}
<i>Notes:</i> $A \leq B \leq C \leq D$ and A_{FDV} is as small as possible (*) both $CIR = 0$ and $EIR = 0$ is not allowed as this results in no conformant Service Frames				

Table 2: Service Class Model for Mobile Backhauling

This model does not provide any references to target values for these performance objectives but it expresses the relationship among all class of services: they are in decreasing order from the Very High class (H⁺) to Low (L). Note also that the H⁺ class could offer the same performance as the H class in terms of FD and FLR but introduces a more stringent requirement for the FDV. The table also contains an indication related to the bandwidth profiles (CIR and EIR) for each Class of Service.

This is a general CoS model based on the assumption that the mobile backhaul service is provided by a single Service Provider. The following tables provide examples on how mobile backhaul traffic classes could be mapped respectively into 4, 3 and 2 Classes of Service:

Service Class Name	Example of Generic Traffic Classes mapping into CoS		
	4 CoS Model	3 CoS Model	2 CoS Model
Very High (H ⁺)	Synchronization	-	-
High (H)	Conversational, Signaling and Control	Conversational and Synchronization, Signaling and Control	Conversational and Synchronization, Signaling and Control, Streaming
Medium (M)	Streaming media	Streaming media	-
Low (L)	Interactive and Background	Interactive and Background	Interactive and Background

Table 3 : Examples of MBH Traffic Classes mapping into 4, 3 and 2 CoS Models

In [R9] and [R10], Class of Service is specified as per one of the sections 6.8.1, 6.8.2, or 6.8.3 in [2].

[R9] At least two Classes of Service **MUST** be supported.

[R9] means that an EVC must be able to offer a minimum of two Classes of Service, but it does not require their use.

These two Classes of Service could be based on two of the service classes specified in Table 2, e.g. the H and L classes.

[R10] Four Classes of Service **SHOULD** be supported.

The four Classes of Service could be based on the four service classes specified in Table 2.

7.2 Applying MEF Service Definitions to Mobile Backhaul

This section specifies the service attributes and related parameter values for mobile backhaul Ethernet services for a given service type. These service attributes are based on the normative text defined in MEF 10.1 [2] and the service definitions defined in MEF 6.1 [1]. The Ethernet services discussed in this section are not exhaustive and variations of these service definitions may exist.

[R11] The mobile backhaul Ethernet service **MUST** comply with one of the following Ethernet service definitions as defined in [1]:

- a. Ethernet Private Line Service
- b. Ethernet Virtual Private Line Service
- c. Ethernet Private LAN Service
- d. Ethernet Virtual Private LAN service
- e. Ethernet Private Tree Service

f. Ethernet Virtual Private Tree Service

The RAN NC itself can be viewed as a service multiplexing facility in that it can support large numbers of RAN BS sites. Often the RAN NC is in a single location that gives mobile providers several options to connect RAN BSs with the RAN NC, including: a port-based implementation with one UNI per RAN BS, or a VLAN-based implementation with EVCs from different RAN BSs service multiplexed at one or more RAN NS UNIs. When several EVCs are multiplexed on a single UNI, there is a risk of a single point of failure, and therefore an appropriate traffic protection schema should be employed. A similar approach may also be adopted at other UNIs in the mobile backhaul network, for example at RAN BS sites with several base stations. Traffic protection schemas for these scenarios are for further study.

7.2.1 Ethernet Private Line Service

Ethernet Private Line (EPL) services are similar to the leased line services (E1/T1) that are typically used to backhaul traffic between the RAN NC and RAN BS. The EPL service may be preferred in cases where there is a desire for a 1:1 correspondence between the RAN NC and each RAN BS UNI with Class of Service (CoS) indication based on DSCP or PCP marking. In the case ingress service frames are untagged; CoS indication will be solely based on the DSCP marking of Service Frames.

As illustrated in Figure 7 below, when using EPL services there will be a 1:1 RAN NC UNI to RAN BS UNI ratio. Meaning there will be a single RAN NC UNI per RAN BS UNI.

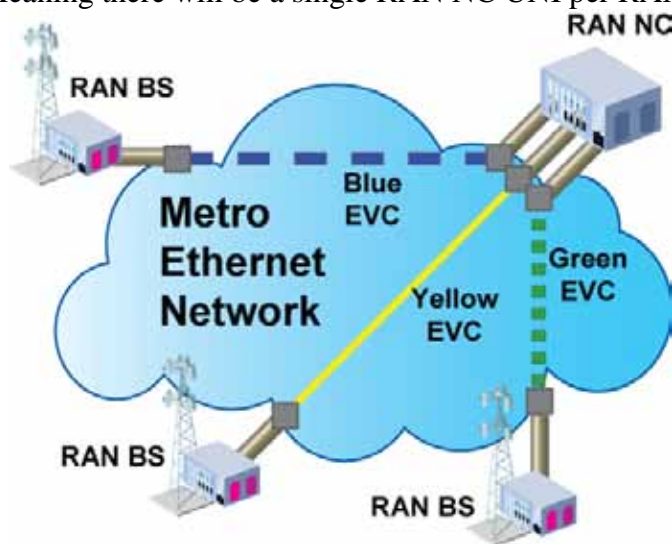

Figure 7: Ethernet Private Line (EPL) Service

[R12] When EPL is implemented, each EVC and each UNI **MUST** support all mandatory requirements of EPL as defined in MEF 6.1 section 7.1 and 8.1.

[R13] When EPL is implemented, each EVC and each UNI **SHOULD** support all optional requirements of EPL as defined in MEF 6.1 section 7.1 and 8.1.

7.2.2 Ethernet Virtual Private Line Service

Most mobile backhaul networks today are composed of point-to-point services. The Ethernet Virtual Private Line (EVPL) service may be used to emulate existing service offerings with a point-to-point relationship between each RAN NC site and each RAN BS site. EVPL supports multiplexing at the UNI. This allows services between the RAN BS and RAN NC to be multiplexed at the RAN NC UNI, as illustrated in Figure 8.

Note that if traffic is separated over multiple EVCs between a RAN NC and the RAN BSs attached to the MEN, then there is an upper bound of 4095 RAN BSs that can be connected to a given RAN NC UNI.

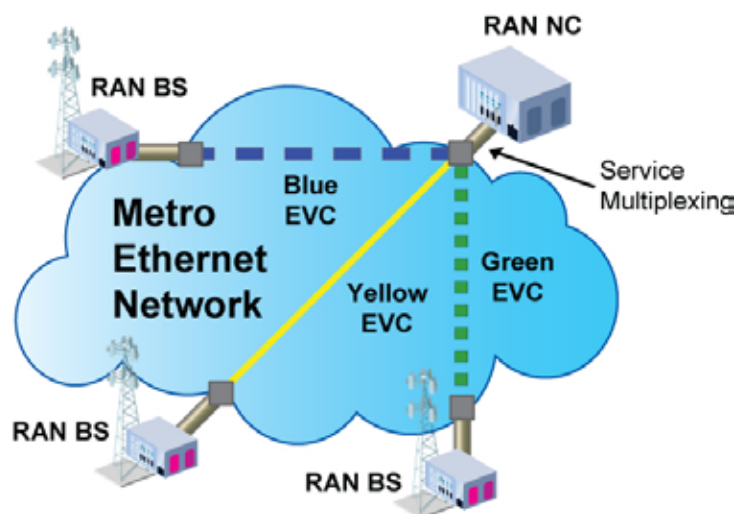

Figure 8: Ethernet Virtual Private Line (EVPL) Service

- [R14] When EVPL is implemented, each EVC and each UNI **MUST** support all mandatory requirements of EVPL as defined in MEF 6.1 section 7.2 and 8.2.
- [R15] When EVPL is implemented, each EVC and each UNI **SHOULD** support all optional requirements of EVPL as defined in MEF 6.1 section 7.2 and 8.2.

7.2.3 Ethernet Private LAN Service

Mobile operators with multiple RAN NC sites or deployments where inter RAN BS communication is permitted may want to interconnect them at high speeds so all sites appear to be on the same Local Area Network (LAN) and have equivalent performance. The Ethernet Private LAN (EP-LAN) service as defined in this subsection, using the E-LAN service type, provides a highly transparent service that connects multiple UNIs.

The EP-LAN service is defined to provide All to One bundling at each UNI, CE-VLAN ID preservation, CE-VLAN CoS preservation, and tunneling of key Layer 2 Control Protocols. A key advantage of this approach is that if the mobile operator has outsourced its backhaul network to another service provider or different company, e.g., transport/transmission network organization, the mobile operator can configure VLANs at the RAN NCs and the RAN BSs without any need to coordinate with the other Service Provider.

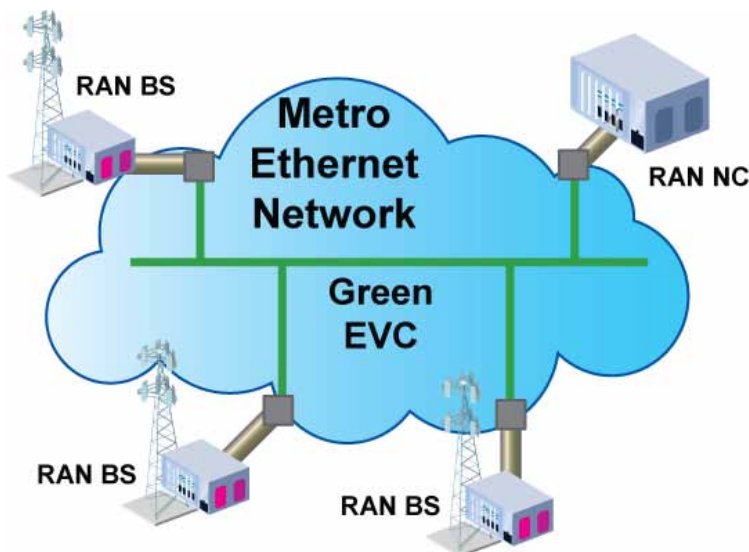

Figure 9: Ethernet Private LAN (EP-LAN) Service

- [R16]** When EP-LAN is implemented, each EVC and each UNI **MUST** support all mandatory requirements of EP-LAN as defined in MEF 6.1 section 7.3 and 8.3.
- [R17]** When EP-LAN is implemented, each EVC and each UNI **SHOULD** support all optional requirements of EP-LAN as defined in MEF 6.1 section 7.3 and 8.3.

7.2.4 Ethernet Virtual Private LAN Service

Some mobile operators commonly desire an E-LAN service type to connect their UNIs in a Carrier Ethernet network, while at the same time accessing other services from one or more of those UNIs. An example of such a UNI is a mobile operator site that has co-siting of RAN BS of different technologies, e.g. legacy GSM and WiMAX. Each technology may have a specific EVC assigned to transport mobile backhaul traffic and different UNI peers. The Ethernet Virtual Private LAN (EVP-LAN) service is defined in this subsection to address this need.

The EVP-LAN service may provide similar transparency as the EP-LAN case. For example, bundling may or may not be used on the UNIs in the Multipoint-to-Multipoint EVC. As such, CE-VLAN ID preservation, CE-VLAN Cos preservation, and tunneling of certain Layer 2 Control Protocols may or may not be provided.

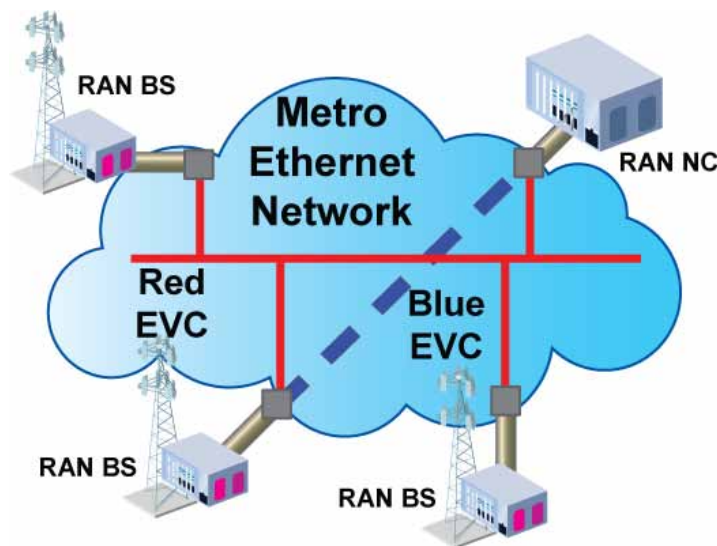

Figure 10: Ethernet Virtual Private LAN (EVP-LAN) Service

- [R18] When EVP-LAN is implemented, each EVC and each UNI **MUST** support all mandatory requirements of EVP-LAN as defined in MEF 6.1 section 7.4 and 8.4.
- [R19] When EVP-LAN is implemented, each EVC and each UNI **SHOULD** support all optional requirements of EVP-LAN as defined in MEF 6.1 section 7.4 and 8.4.

7.2.5 Ethernet Private Tree Service

Mobile operators with multiple sites may want to interconnect them to provide services other than those that resemble a LAN. These services may be distributed from a single or several centralized sites where the distribution sites are designated as roots and all the remaining sites are designated as leaves.

Traditionally in mobile backhaul the RAN BS sites only need to exchange Service Frames with the RAN NC site(s) and not with other RAN BSs. This behavior is possible in an Ethernet Private Tree (EP-Tree) service, where the RAN NC site(s) would be root(s) and the RAN BS sites would be leaves.

The EP-Tree service is defined to provide All to One bundling, CE-VLAN ID preservation, CE-VLAN CoS preservation, and tunneling of key Layer 2 Control Protocols. A key advantage of this approach is that the mobile operator can configure VLANs across the sites without any need to coordinate with the Service Provider.

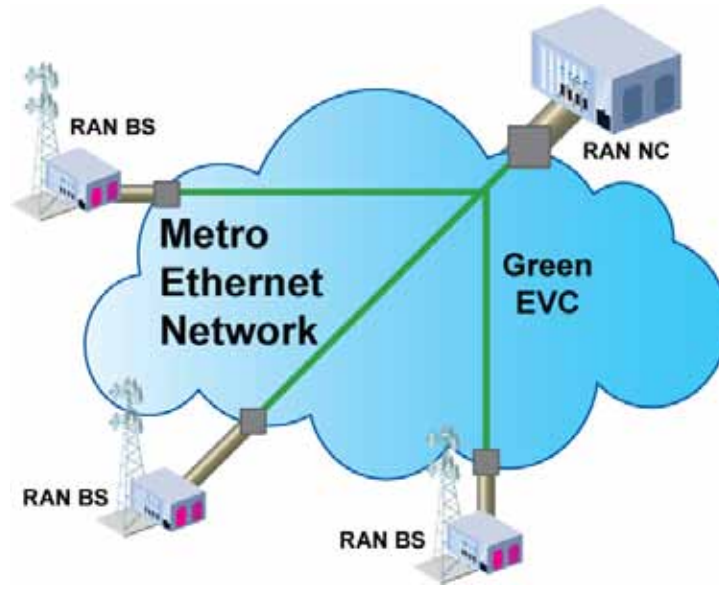

Figure 11: Ethernet Private Tree (EP-Tree) Service

- [R20] When EP-Tree is implemented, each EVC and each UNI **MUST** support all mandatory requirements of EP-Tree as defined in MEF 6.1 section 7.5 and 8.5.
- [R21] When EP-Tree is implemented, each EVC and each UNI **SHOULD** support all optional requirements of EP-Tree as defined in MEF 6.1 section 7.5 and 8.5.
- [R22] When EP-Tree is implemented, the UNI Type of all RAN NC UNIs **MUST** be Root and the UNI Type of all RAN BS UNIs **MUST** be Leaves.

7.2.6 Ethernet Virtual Private Tree Service

Some mobile operators desire to keep the root-leaf relationship between RAN NC and RAN BS sites, but also want to multiplex services at one or more of the interconnected UNIs. For such cases, the EVP-Tree service is used.

Bundling may or may not be used on the UNIs in the Rooted-Multipoint EVC. As such, CE-VLAN ID preservation, CE-VLAN Cos preservation, and tunneling of certain Layer 2 Control Protocols may or may not be provided. Figure 12 below shows the basic structure of EVP-Tree service. The figure below is an example where the EVP-Tree service is used to transport mobile voice and data traffic, while the EVP-LAN service offers an inter-site connection for node and site management.

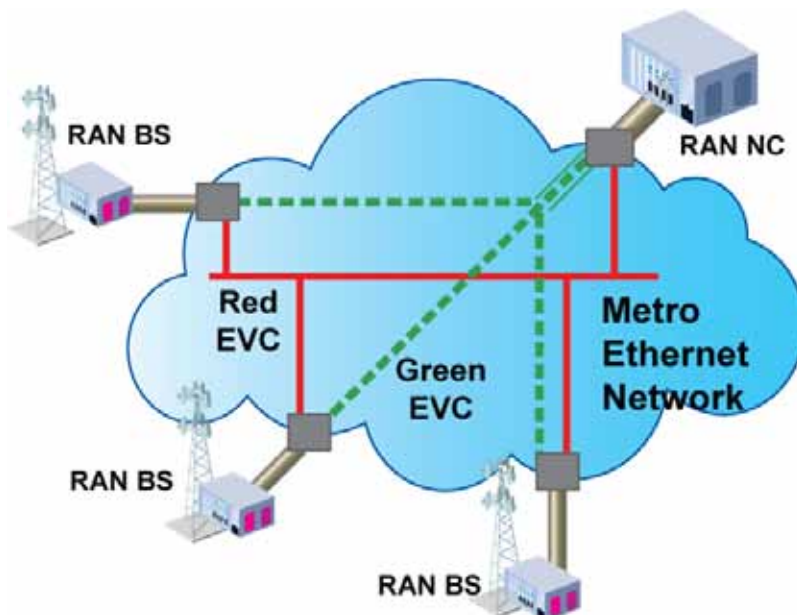

Figure 12: Ethernet Virtual Private Tree (EVP-Tree) Service

- [R23] When EVP-Tree is implemented, each EVC and each UNI **MUST** support all mandatory requirements of EVP-Tree as defined in MEF 6.1 section 7.6 and 8.6.
- [R24] When EVP-Tree is implemented, each EVC and each UNI **SHOULD** support all optional requirements of EVP-Tree as defined in MEF 6.1 section 7.6 and 8.6.
- [R25] When EVP-Tree is implemented, the UNI Type of all RAN NC UNIs **MUST** be Roots and the UNI Type of all RAN BS UNIs **MUST** be Leaves.

7.3 Synchronization

The synchronization requirements specified in this document are derived from the ITU-T Recommendation G.8261, which studies timing and synchronization over packet based networks; and also examines the requirements for different mobile technologies.

There are three scenarios related to timing distribution in a mobile network:

1. timing is distributed outside the packet network (e.g. via GPS or via a legacy TDM network);
2. timing is distributed via packet based methods;
3. timing is distributed over the Ethernet physical layer (synchronous Ethernet).

Method 1 is outside of the scope of this document and will not be studied further. Method 2 is examined in the scope of Phase 1 and method 3 is for further study.

There are currently no strict requirements in G.8261 on the transport network to meet the synchronization requirements on the mobile air interface for the synchronization scenarios within the scope of Phase 1. These are for further study [18].

Hence G.8261 does not provide hard performance requirements that can be used to define the performance attribute values for MEF Ethernet services. Subsequent versions of this document will be updated to reflect additional recommendations that are defined in G.8261.

7.3.1 Packet Based Methods

This approach uses a dedicated packet stream or packet data, such as in the case of Circuit Emulation Services over Ethernet (CESoE), to distribute timing information.

Packet based methods may be based on timestamp exchanging protocols, such as IEEE 1588, Precision Time Protocol (PTP) [24] or IETF Network Time Protocol (NTP) [25]. These timestamps can be used to support generation of frequency; in fact the notion of time carried by the timestamps compared with the time generated by the local oscillator can be used to recover a frequency reference for the local oscillator. The timing (frequency) information may also be directly recovered from the packets inter-arrival times. These techniques are also known as adaptive clock recovery methods.

Typically the adaptive clock recovery method uses a master-slave hierarchy, where the source clock is distributed from a Primary Reference Clock (PRC). An example is depicted in the Figure 13 below.

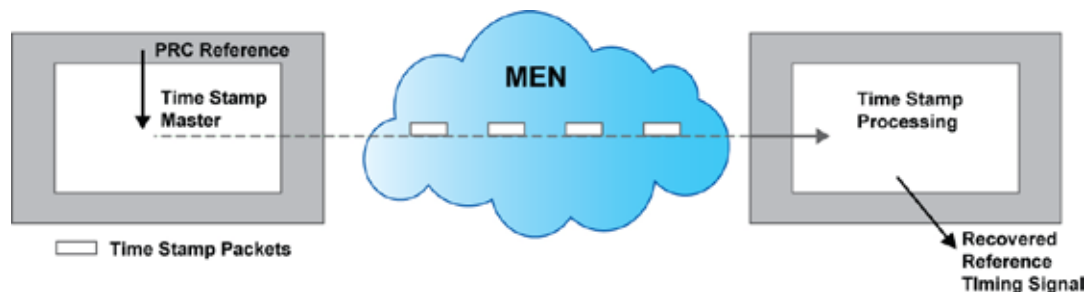

Figure 13 : Example of packet based method with timing distribution of the Reference Timing Signal via Timestamps

Frame Delay Variation can affect the operation of the clock recovery in case adaptive clock recovery methods are applied (see clause 10.1.2 in G.8261). It shall be noted that in addition to the Frame Delay Variation as defined in [2], the performance of the adaptive clock recovery methods depends on several other factors: e.g. shape of the Frame Delay distribution, non stationary behavior of the Frame Delay, characteristics of the oscillator in the GIWF, etc.

When using adaptive clock recovery methods it is preferable to carry timing over a well engineered network with the timing flow carried in a channel that minimises the packet network impairments. A part of this process may be to assign the highest priority to such a flow. What constitutes a well engineered network to transport timing is for further study. It should be noted that the shared nature of transmission implies that all flows interfere with each other to some degree regardless of priority with respect to timing.

As part of this study in G.8261, additional metrics (based on Frame Delay) and the related requirements are being defined (see also work done in ITU-T Study Group 15 Question 13).

Differential methods can also be used to recover timing from packets. In this case, the timestamp needs only to be a relative value and can be used as an estimate of phase. Since phase and frequency are related, it is possible to use this relative information to recreate a frequency reference. This is known as differential timing (see also G.8261).

When using a packet based method, it could be possible to derive the MEN EVC performance objectives (FD, FDV, FLR, and Availability) needed to be based on the requirements for the Packet based Equipment Clock (PEC) Interface Network Limits as defined in G.8261 Section 9.2.2, Deployment Case 2.

The performance objectives for Ethernet services using a packet based method are for further study.

Note: radio base stations normally include very stable oscillators. A proper choice of the oscillator in the Base Station can decrease the required EVC performance objectives needed to guarantee the synchronization requirements on the radio interface are always fulfilled.

The following scenarios illustrate the possibilities for delivering synchronization over Ethernet services when using a packet based method.

- 1.) Bundled with other traffic types in an EVC and separated by CoS ID and allocated the highest service class as specified in 7.1;
- 2.) Over a dedicated EVC.

Additional considerations on the use of packet based methods are found in [18] sections 12.1 and 12.2.2.

7.3.2 Synchronous Ethernet Methods

The general principles of Synchronous Ethernet PHY are defined in ITU-T G.8261 and the clock is defined in ITU-T G.8262. Note that this method can be used to deliver frequency, but not time of day. Synchronous Ethernet Methods are for further study.

7.3.3 Synchronization Requirements for TDM-Based Interfaces

While the internal implementation details of the GIWF are out of the scope of this document the synchronization requirements that apply for TDM based interfaces are clearly specified in ITU-T G.8261. The following requirements apply for TDM based interfaces.

[R26] The method of synchronization used **MUST** be such that jitter and wander measured at the output of the GIWF TDM-bound interface meet the traffic interface requirements specified in ITU-T recommendations [20] for E1 and E3 circuits, and [21] for DS1 and

DS3 circuits and, in case of SDH signals, that meet the network limits for the maximum output jitter and wander at the relevant STM-N hierarchical interface as specified by [22].

- [R27] The method of synchronization used **SHOULD** be such that the wander budget allocated to the MEN and the GIWF as measured at the output of the GIWF TDM interface meets the traffic interface requirements of ITU-T G.8261, Deployment Case 2 [18].
- [R28] Jitter and wander that can be tolerated at the input of the GIWF TDM input **MUST** meet the traffic interface requirements specified in ITU-T recommendations [20] for E1 and E3 circuits, and [21] for DS1 and DS3 circuits and in case of SDH signals, the GIWF TDM **MUST** meet the jitter and wander tolerance for STM-N input ports as specified by [22].

8. Generic Inter-working Function MEN Interface Requirements

As noted in Section 4 a GIWF is required to provide adaptation and interconnection between TDM-based mobile equipments in the RAN BS and RAN NC, and the existing UNI in the Metro Ethernet domain. This implementation agreement specifies the functional requirements for the MEN facing interface of the GIWF. Requirements on this Ethernet interface, referred herein as the MEN interface, are specified below.

Note: This implementation agreement is agnostic to the mechanisms used to adapt TDM-based RAN BS and RAN NC interfaces to MEF defined services. Requirements specific to the adaptation of the legacy mobile traffic to the MEN service are defined elsewhere, such as MEF 8 Implementation Agreement for the Emulation of PDH Circuits over Metro Ethernet Networks [8] and the IP/MPLS Forum's MPLS in Mobile Backhaul Networks Framework and Requirements Technical Specification [27] that specifies TDM, ATM, and HDLC over MPLS over Ethernet, and are out of scope of this specification.

- [R29] The GIWF's MEN interface **MUST** comply with all mandatory UNI-C functions as defined in Section 6 and Section 7 of this implementation agreement.
- [R30] The GIWF's MEN interface **MAY** comply with any or all optional UNI-C functions as defined in Section 6 and Section 7 of this implementation agreement.

9. References

- [1] MEF Technical Specification MEF 6.1, “Ethernet Services Definitions - Phase 2”
- [2] MEF Technical Specification, MEF 10.1, “Ethernet Services Attributes - Phase 2”
- [3] MEF Technical Specification, MEF 13 “User Network Interface (UNI) Type 1 Implementation Agreement”
- [4] MEF Technical Specification, MEF 20, “User Network Interface (UNI) Type 2 Implementation Agreement”
- [5] MEF Technical Specification, MEF 17 “Service OAM Requirements & Framework”
- [6] MEF Technical Specification, MEF 3 “Circuit Emulation Service Definitions, Framework and Requirements in Metro Ethernet Networks”
- [7] MEF Technical Specification, MEF 11 “User Network Interface (UNI) Requirements and Framework”
- [8] MEF Implementation Agreement, MEF 8, “Implementation Agreement for the Emulation of PDH Circuits over Metro Ethernet Networks”
- [9] IEEE 802.1D-2004, “Part 3: Media Access Control (MAC) Bridges”
- [10] IEEE 802.1Q – 2006, “Virtual Bridged Local Area Networks”
- [11] IEEE 802.3-2005, “Part 3: Carrier sense multiple access with collision detection (CSMA/CD) access method and physical layer specifications”
- [12] RFC 2119, “Key words for use in RFCs to Indicate Requirement Levels”, S. Bradner
- [13] ITU-T Y.1540 IP Packet Transfer And Availability Performance Parameters
- [14] 3GPP TS 23.107, “QoS Concept and Architecture”
- [15] IEEE 802.16e-2005, Air Interface for Fixed and Mobile Broadband Wireless Systems
- [16] WiMAX Forum End-to-End Network Systems Architecture, Stage 2: Architecture Tenets, Reference Model and Reference Points
- [17] ITU-T Y.1541 Network Performance Objectives For IP-Based Services
- [18] ITU-T G.8261 Timing and Synchronization Aspects in Packet Networks (2008)
- [19] ITU-T G.8262 Timing Characteristics of Synchronous Ethernet Equipment Slave Clock (EEC)

- [20] ITU-T G.823 The control of jitter and wander within digital networks which are based on the 2048 kbit/s hierarchy
- [21] ITU-T G.824 The control of jitter and wander within digital networks which are based on the 1544 kbit/s hierarchy
- [22] ITU-T G.825 The control of jitter and wander within digital networks which are based on synchronous digital hierarchy (SDH)
- [23] IEEE Std 802.16e-2005 "Part 16: Air Interface for Fixed and Mobile Broadband Wireless Access Systems
- [24] IEEE 1588 – 2002, “Standard for A Precision Clock Synchronization Protocol for Network Measurement and Control Systems”
- [25] RFC 1305 – 1992, “Network Time Protocol (Version 3) – Specification, Implementation, and Analysis”
- [26] ITU-T G.705 Characteristics of plesiochronous digital hierarchy (PDH) equipment functional blocks
- [27] IP/MPLS Forum 20.0.0, "MPLS in Mobile Backhaul Networks Framework and Requirements Technical Specification" (October 2008)

10. Appendix A – Generic Inter-working Function (Informative)

This Appendix provides an informative definition of the Generic Inter-working Function.

The Generic Inter-working Function (GIWF) provides functionality that allows RAN CE devices with a Non-Ethernet I/F to send traffic over an Ethernet UNI. A detailed description of the GIWF is outside the scope of this document; however, the IWF definition described in MEF 3 can be used as an example for a PDH based Non-Ethernet I/F.

Non-Ethernet I/F is a generic term that refers to a non-Ethernet based interface, e.g. ATM or TDM. A GIWF is only needed if the RAN CE has a Non-Ethernet I/F and therefore can not directly connect to the UNI. Figure 14 is based on the IWF defined in MEF 3 and illustrates where the GIWF would be located.

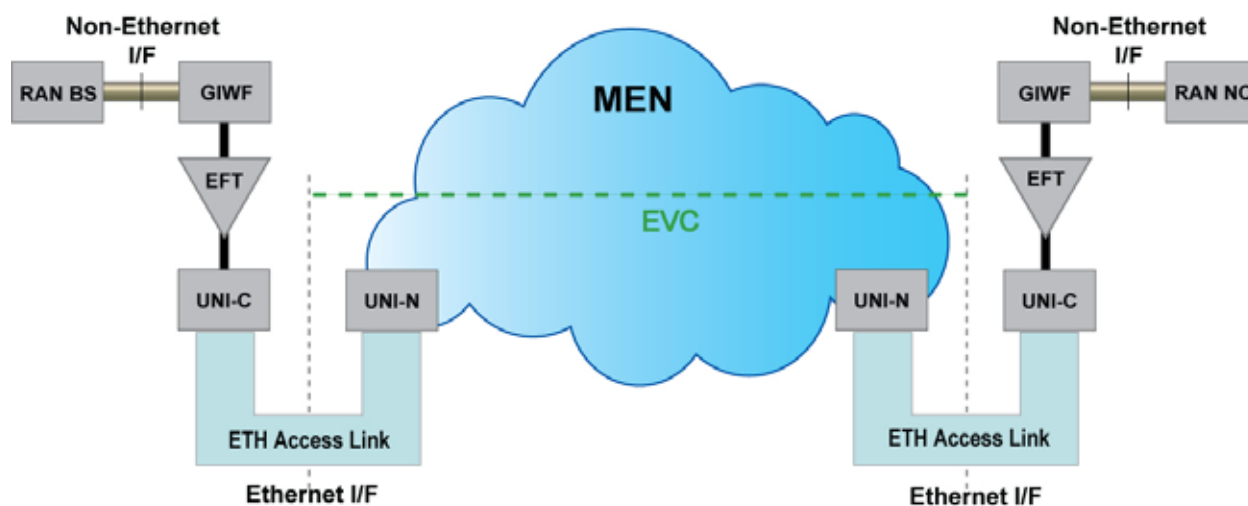

Figure 14: Generic Inter-working Function

The GIWF may perform none, part of or all the UNI-C functions. If the GIWF does not perform all the functions expected by the UNI-C then it is expected that another device is located in front of the GIWF towards the MEN that performs the remaining UNI-C functions. All ingress Service Frames from the GIWF through the Ethernet Flow Termination (EFT) point towards the UNI must be conformant to the Ethernet frame format as defined in MEF 10.1 and the IA of the UNI type that is used, e.g. MEF 13 [3] for UNI Type 1. The GIWF should separate traffic such that the EFT can apply the proper CE-VLANs and/or CoS marking. Although the GIWF may perform some UNI-C functions, this does not imply that the GIWF must be owned and operated by the mobile network operator.

With respect to synchronization, the GIWF may contain functions to support synchronization over the MEN. The details of these functions are outside the scope of this document and left for further study.

11. Appendix B – Mobile Backhaul User Traffic Classes (Informative)

Several traffic classes are identified for the mobile backhaul and the WCDMA, CDMA2000, and WiMAX¹ standards define their own user service classes. Examples of the WCDMA and WiMAX user service classes are shown below. Each user service class is coupled with delay, delay variation, frame loss, and availability performance requirements.

Traffic Class	Example Application	Fundamental Characteristics
Conversational class	Voice	- Conversational RT - Preserve time relation (variation) between information entities of the stream - Conversational pattern (stringent and low delay)
Streaming class	Streaming video	- Streaming RT - Preserve time relation (variation) between information entities of the stream
Interactive class	Web browsing	- Interactive best effort - Request response pattern - Preserve payload content
Background	Background download of emails	- Background best effort - Destination is not expecting the data within a certain time - Preserve payload content

Table 4: WCDMA User Service Classes (Source: 3GPP 23.107)

Traffic Class	Example Application	Fundamental Characteristics
UGS (Unsolicited Grant)	VoIP (without silence suppression)	For real-time applications generating fixed-rate data, which require guaranteed data rate, delay, and jitter
ERT-VR (Extended Real-Time Variable Rate)	VoIP (with silence suppression)	For real-time applications with variable data rates, which require guaranteed data rate, delay, and jitter
RT-VR (Real-Time Variable Rate)	Video	For real-time data applications with variable data rates that require guaranteed data rate and delay.
NRT-VR (Non-Real-Time Variable Rate)	FTP	For applications that require guaranteed data rate but are insensitive to delays
BE (Best Effort)	Background download of emails, web browsing	For applications with no data rate or delay requirements

Table 5: WiMAX User Service Classes (Source: IEEE 802.16e)

In addition, there are control and management plane traffic types that are not included in the tables above. One way to handle these traffic types could be to bundle them into a single service class, e.g. control class. The performance expectation for this class is high availability with low frame delay and frame loss.

Synchronization signaling could be delivered using the control class, but this would mean that control class would need to conform to the requirements of the synchronization method used to distribute timing. Alternatively, synchronization could be delivered using a separate class that would typically have stringent frame delay, frame delay variation, frame loss, and availability performance requirements.

¹ 3GPP does not define traffic classes for GSM.

12. Appendix C – Mobile Backhaul Services (Informative)

The scope of this Appendix is to provide information describing several Use Cases for delivering Ethernet based mobile backhaul services. These services run between the RAN NC and the RAN BS as defined by this implementation agreement.

The use cases presented here assume that the backhaul network (MEN) is owned by a single operator (assumption made for Phase 1). These use cases are not meant to be exhaustive; additional use cases addressing different assumptions are for further study.

This section describes 3 different scenarios and related assumptions for delivering data and control plane traffic; they are referred in the following as:

1. EVP Line per RAN BS
2. EVP Tree per group of RAN BSs
3. EVP-Tree per Service

In addition, the Appendix describes two alternatives for delivering management plane traffic.

12.1 Use Case 1: EVP Line per RAN BS

Use Case 1 illustrates a mobile backhaul network with a distinct EVP Line service between each RAN BS and RAN NC with the following configurations:

- The RAN NC uses a configured CE-VLAN ID to identify a RAN BS in the mobile backhaul network. The CE-VLAN ID is mapped at the RAN NC UNI-N and at the RAN BS UNI-N to the EVC connecting the RAN BS and RAN NC. This implies that each RAN NC UNI can distinguish up to four thousand distinct RAN BSs.
- At the RAN NC side the CE-VLAN ID assignment is performed at the UNI-C; at the RAN BS side the CE-VLAN ID assignment can be either performed at the UNI-C or at the UNI-N, according to which option - described later in this paragraph - is selected.
- Bundling is disabled which means that all traffic types are sent on the same CE-VLAN ID.
- Multiple Classes of Service can be supported; they are differentiated through either PCP or DSCP marking. CoS ID is identified by <EVC+PCP> or <EVC+DSCP>. In this use case CoS ID preservation is enabled and 4 classes of service are supported.

Both Figure 15 and Table 6 show an example of how Ethernet Services can be delivered in the mobile backhaul according to the assumptions made for the present use case.

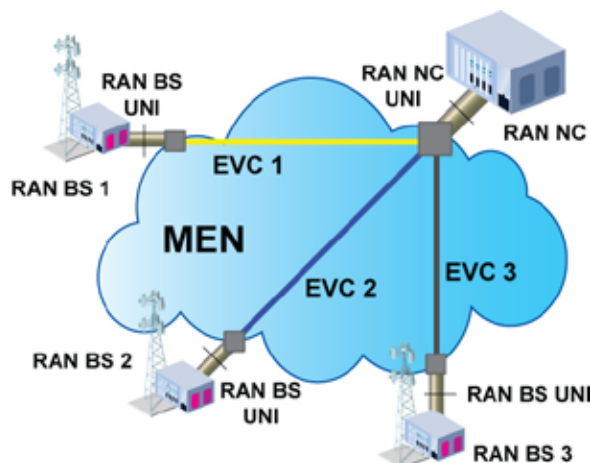

Figure 15: EVP Line per RAN BS – Use Case 1

EVC ID	EVC End Points	Ethernet Service
EVC_1	BS 1, NC	EVP-Line
EVC_2	BS 2, NC	EVP-Line
EVC_3	BS 3, NC	EVP-Line

Table 6: EVP Line per RAN BS – Use Case 1

Use Case 1 may also take into consideration additional factors that result in four possible options, each considering a different service frame format at the RAN BS UNI-C:

- **Option A:** The CE-VLAN ID Preservation Attribute is enabled and the RAN BS UNI-C transmits/receives tagged service frames to/from the RAN BS UNI-N with the CE-VLAN ID preconfigured for the RAN BS itself; either PCP or DSCP values specify different Classes of Service.
- **Option B:** The CE-VLAN ID Preservation Attribute is disabled and the RAN BS UNI-C transmits/receives untagged service frames to/from UNI-N where they are mapped to the default CE-VLAN ID; DSCP values specify different Classes of Service. A default mapping of untagged service frames is configured at each RAN BS UNI-N.
- **Option C:** The CE-VLAN ID Preservation Attribute is disabled and the RAN BS UNI-C transmits priority tagged service frames² towards the UNI-N, where they are mapped to the default CE-VLAN ID, and receives untagged frames; PCP values specify different Classes of Service. A default mapping of priority tagged service frames is configured at each RAN BS UNI-N.
- **Option D:** The CE-VLAN ID Preservation Attribute is disabled and BS UNI-C transmits/receives tagged service frames to/from UNI-N with a preconfigured CE-VLAN ID, identical for each BS. Either PCP or DSCP values specify different Classes of Service.

² The priority tagged frame is defined by MEF 10.1 as a Service Frame with an IEEE 802.1Q tag in which the CE-VLAN ID field is set to 0.

Options B, C and D may ease the configuration of the RAN BS because they are agnostic to the CE-VLAN ID value used to identify Service Frames in the mobile backhaul.

Table 7 shows an example of the CE-VLAN ID / EVC mapping for each option and the configuration both at the RAN BS UNI-N and at the RAN NC UNI-N:

EVC ID	CE-VLAN ID at RAN BS UNI-N				CE-VLAN ID at RAN NC UNI-N
	Option A	Option B	Option C	Option D	
EVC_1	10	*(3)	*	25	10
EVC_2	20	*	*	25	20
EVC_3	30	*	*	25	30

Table 7: Example of CE-VLAN ID \ EVC mapping both at RAN BS UNI-N and at RAN NC UNI-N

Table 8 shows an example of how to differentiate multiple Classes of Service running over the same EVC through PCP values:

CoS ID <EVC+PCP>	Class of Service	Traffic Class Example
< EVC_ID+6>	Instance of H ⁺ class	Synchronization
< EVC_ID+5>	Instance of H class	Conversational, Signaling and Control
< EVC_ID+4>	Instance of M class	Streaming
<EVC_ID+3>	Instance of L class	Interactive and Background

Table 8: Example of multiple CoS IDs based on <EVC+PCP> – Use Case 1

The CoS ID Preservation attribute should be enabled for each option in order to simplify configuration.

Note that the CoS ID per <EVC> model can also be supported by Use Case 1 if the assumption to use a single EVP Line per RAN BS that supports multiple services is removed. According to this new assumption each RAN BS can support multiple EVP Lines whereby mobile traffic classes may be grouped into different EVCs. Each EVP Line is mapped to a unique CE-VLAN ID and so each CE-VLAN ID identifies a specific set of services between the RAN NC and a specific RAN BS.

12.2 Use Case 2: EVP Tree per group of RAN BSs

Use Case 2 explores the option of connecting RAN CEs using an EVP-Tree service with the following configurations:

³ The symbol * indicates the CE-VLAN ID value used at the UNI for both untagged and priority tagged frames.

- Groups of k_i ⁴ RAN BSs are uniquely identified at the RAN NC by a CE-VLAN ID⁵. Associating several RAN BSs to the same CE-VLAN ID allows one to overcome the VLAN ID address space limitation affecting the previous use case.
- An EVP-Tree is established between the RAN BSs (acting as leaves) belonging to the same group and the RAN NC (acting as root) and it is associated to the CE-VLAN ID reserved for that group of RAN BSs
- At the RAN NC side the CE-VLAN ID assignment is performed at the UNI-C; at the RAN BS side the CE-VLAN ID assignment can be either performed at the UNI-C or at the UNI-N, according to which option (A, B, C or D) is chosen (as per Use Case 1) when deploying EVP-Tree services.
- Bundling is disabled which means that all traffic types are sent on the same CE-VLAN ID.
- Multiple Classes of Service can be supported; they are differentiated through either PCP or DSCP marking. CoS ID is identified by <EVC+PCP> or <EVC+DSCP>. In this use case CoS ID preservation is enabled and 4 classes of service are supported.

Figure 16 shows an example about how Ethernet Services can be delivered in the mobile backhaul according to the assumptions made for the present use case.

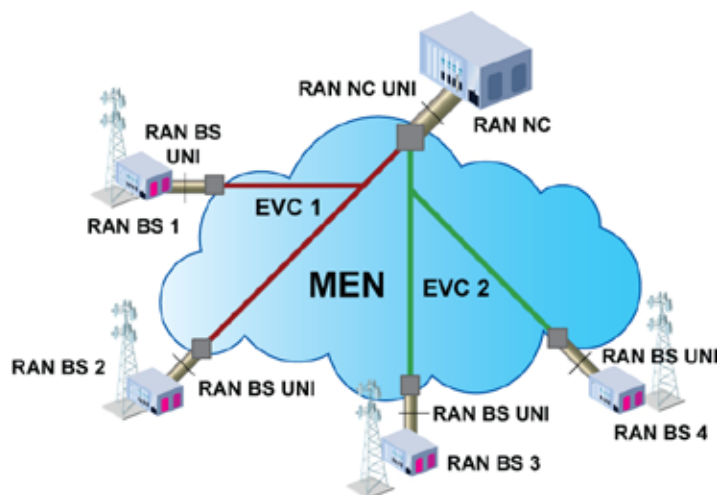

Figure 16: EVP-Tree per group of RAN BSs – Use Case 2

EVC ID	EVC End Points	Ethernet Service
EVC_1	BS 1, BS2, NC	EVP-Tree
EVC_2	BS 3, BS 4, NC	EVP-Tree

Table 9: EVP Tree per group of RAN BSs – Use Case 2

⁴ k_i indicates the number of RAN BSs belonging to the i -th group. This scenario can be extended to the case of a single group including all the RAN BSs connected to the RAN NC.

⁵ Inside each group each RAN BS is uniquely identified by its own MAC address. Security issues are not taken into account in this Appendix.

Comparing Use Case 2 with the previous one it is possible to note that Use Case 2 replicates for a group of RAN BSs, using EVP Tree services, what Use Case 1 does for a single BS, using a single EVP Line. This leads to the following conclusion: the same four options (A, B, C and D) previously described and focusing on different frame format at the RAN BS UNI-C can also be applied to Use Case 2. Refer to Table 7 and Table 8 to get an example about the CE-VLAN ID / EVC mapping and CoS ID definition for the present scenario.

12.3 Use Case 3: EVP Tree per Service

Use Case 3 illustrates a scenario where traffic classes are separated over multiple EVP-Tree services. The configurations for this service include:

- Each CE-VLAN ID can be configured, to uniquely identify a unique service, which in turn, uniquely identifies a set of traffic classes. This means that the same set of traffic classes (i.e. voice, data, RAN signalling etc.) running between the RAN NC and two or more different RAN BSs will be identified by the same CE-VLAN ID value.
- RAN NCs will be configured as Roots and RAN BSs as Leaves
- The CE-VLAN ID tagging is performed both at the RAN BS UNI-C and at the RAN NC UNI-C. CE-VLAN ID preservation is enabled.
- Traffic classes can be differentiated through their CE-VLAN IDs; alternatively the same CE-VLAN ID can be associated to a set of traffic classes and either PCP or DSCP values can be used to differentiate among them. In other words CoS ID can be defined either per <EVC> or per <EVC+PCP> or per <EVC+DSCP>. CoS ID preservation is enabled.
- Suggested to support 4 CoS.

Figure 17 illustrates an example of how Ethernet services can be delivered in the Use Case 3.

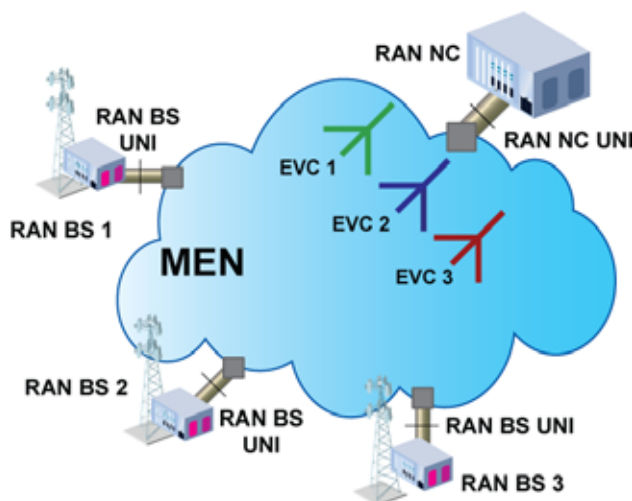

Figure 17: CE-VLAN ID per service – Use Case 3

EVC ID	EVC End Points	Ethernet Service
EVC_1	BS 1, BS2, BS 3, NC	EVP-Tree
EVC_2	BS 1, BS2, BS 3, NC	EVP-Tree
EVC_3	BS 1, BS2, BS 3, NC	EVP-Tree

Table 10: EVP Tree per Service – Use Case 3

In this scenario each RAN BS can be served by different EVP-Trees. Each RAN BS at its own UNI-C transmits/receives tagged frames to/from UNI-N with different CE-VLAN IDs: one for each different set of traffic classes. At RAN BS UNI-N each CE-VLAN ID is mapped to the correspondent EVP Tree service.

Table 11 shows through an example about the CE-VLAN ID / EVC mapping both at RAN BS UNI-N and at RAN NC UNI-N:

EVC ID	CE-VLAN ID at RAN BS UNI-N	CE-VLAN ID at RAN NC UNI-N
EVC_1	10	10
EVC_2	20	20
EVC_3	30	30

Table 11: Example of CE-VLAN ID\EVC mapping both at RAN BS UNI-N and at RAN NC UNI-N

Table 12 shows through an example how CoS could be defined in this scenario:

CoS ID	Class of Service	i.e. Traffic Class
<EVC_1>	Instance of H ⁺ class	Synchronization
<EVC_2+7>	Instance of H class	Conversational,
<EVC_2+6>	Instance of H class	Signaling and Control
<EVC_3+7>	Instance of M class	Streaming
<EVC 3+6>	Instance of L class	Interactive and Background

Table 12: CoS ID both per <EVC> and per <EVC+PCP> - Use Case 3

12.4 Configuration alternatives for Management plane

Management plane traffic can be distributed in the mobile backhaul according to two main alternatives⁶ that apply to all the use cases previously presented:

⁶ Since the management plane is an issue under discussion at several Standards Development Organizations, this Appendix does not preclude description of new alternative proposals in addition to those ones already presented in this chapter.

- Over the same Ethernet Services instantiated for data and control plane traffic, reserving a specific CoS for management traffic
- Over a separate Ethernet Service exclusively for management.

A proposal of Ethernet Service configuration related to the latter alternative is presented in the following text.

The main general assumptions are:

- Management plane is associated to a CE-VLAN ID common to all the RAN BSs and RAN NCs.
- CE-VLAN ID tagging is performed at the UNI-C at both the RAN BS and the RAN NC.
- Different Classes of Service are supported and are differentiated through either PCP or DSCP marking.

In terms of Ethernet Services, the following configuration could be used for management:

- An EVP-Tree, associated to the common CE-VLAN ID, is established between the RAN NC (acting as root) and all the RAN BSs (acting as leaves)
- CoS IDs either per <EVC+PCP> or per <EVC+DSCP>.

Both Figure 18 and Table 13 present an example about how management traffic can be treated in mobile backhaul.

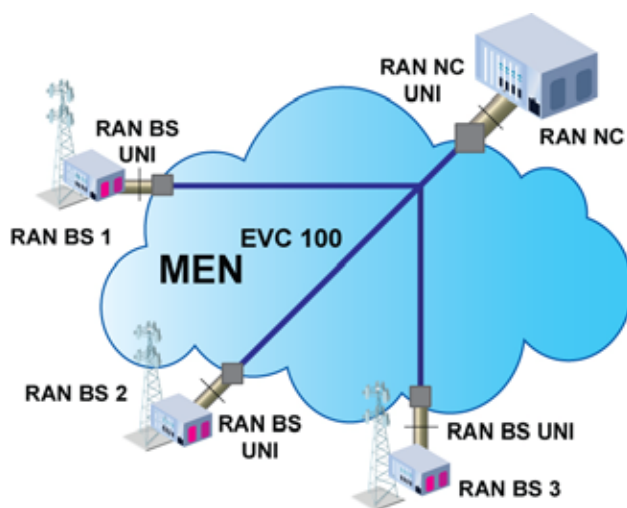

Figure 18: Ethernet Service for Management plane

EVC ID	EVC End Points	Ethernet Service	CE-VLAN ID at RAN BS UNI-N	CE-VLAN ID at RAN NC UNI-N
EVC 100	BS1, BS2, BS3, NC	EVP-Tree	150	150

Table 13: Ethernet Service configuration for Management plane – An example

Tagging is performed at the UNI-C at both the RAN BS and RAN NC sides. One-to-one mapping between CE-VLAN IDs and EVCs is done at the UNI-N at both the RAN BS and the RAN NC sides.

Enabling the CE-VLAN ID Preservation Attribute, the same VLAN ID value is maintained over the EVC easing the configuration of all the appliances in mobile backhaul.

The EVC reserved for management can support multiple Classes of Service: both Figure 19 and Table 14 below show such an example.

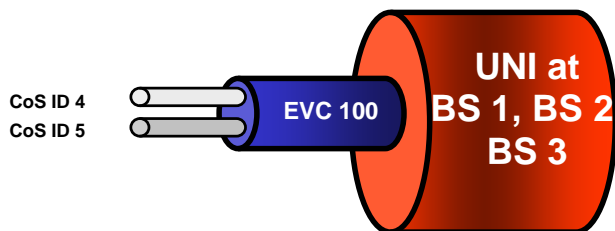

Figure 19: Multiple CoS IDs on the EVC reserved for Management traffic

CoS ID <EVC+PCP>	Class of Service	i.e. Traffic Class
< EVC 100+6>	Instance of H ⁺ class	High Priority Mgt
< EVC_100+5>	Instance of H class	Low Priority Mgt

Table 14: Example of Multiple CoS IDs on the EVC reserved to Management

The CoS ID Preservation Attribute should be enabled in order to simplify the configuration of the mobile backhaul.